











	<b>Model</b>	<b>EW3105</b>
	<b>Code Production</b>	<b>LP713EWNZDD</b>
Interface :		
		



	Overall Dimension (Width-Depth-Height) *open	mm	1465x857(*1400)x1959(*2274)
	Packaging Dimension (WxDxH)	mm	1750x1100x2200
	Gross weight	Kg	317
	Net weight	Kg	301
	Volume	mc	3,85
	Rack size	mm	1320x700
	Max door /hood opening	mm	850
	Max glasses/plate Height	mm	800
	General construction		double skin
	Door/hood Construction		double skin
	Tank construction		fully deep drawn
	Tank volume	liter	131
	Tank heating element	W	10.500
	Tank surface strainers		stainless steel
	Wash pump type		double flow
	Wash pump power	W	2 X 2.700
	Wash temperature	°C	60 (60-65)
	Boiler type		without pressure
	Boiler volume	liter	17
	Back-flow system		break tank
	Boiler heating element	W	10.500
	Rinse booster pump		yes
	Rinse booster pump power	W	200 x 2
	Rinse temperature	°C	80 (80-85)
	Rinse water consumption	Liter /rack	6
	Optimal external water pressure	bar	1 - 6
	Drain system		deep drain
	Drain filter		double filter
	Drain pump		standard built in
	Rinse aid dispenser		YES
	Detergent dispenser		YES
	Wash cycle	sec	120 - 240 - 360 - 720
	Self cleaning cycle		YES
	Electric Power	W	15.900
	Electric Connection	V - ph - Hz	400V 3N 50Hz
	Fuse	A	32
	Steel generic basket		43305
	Electric cable		YES
	Drain hose		YES
	Fill hose		YES

A		50mm M	A EXIT		32 mm M
B		G 3/4" M	B EXIT		G 3/4" F
C		Power supply	E		Steam exhaust

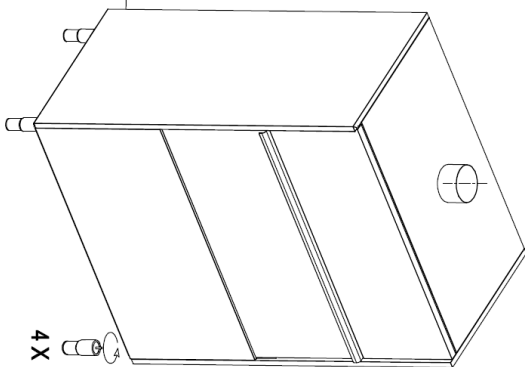
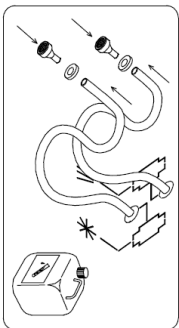
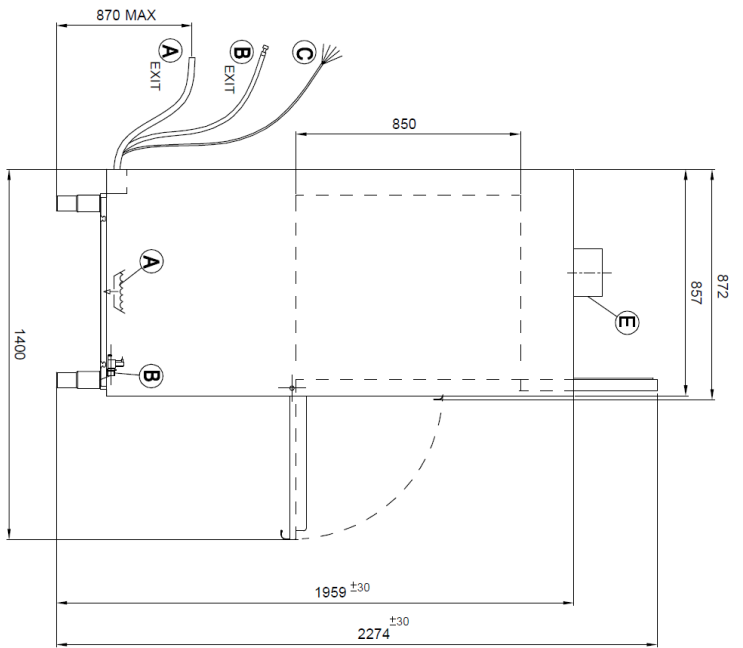
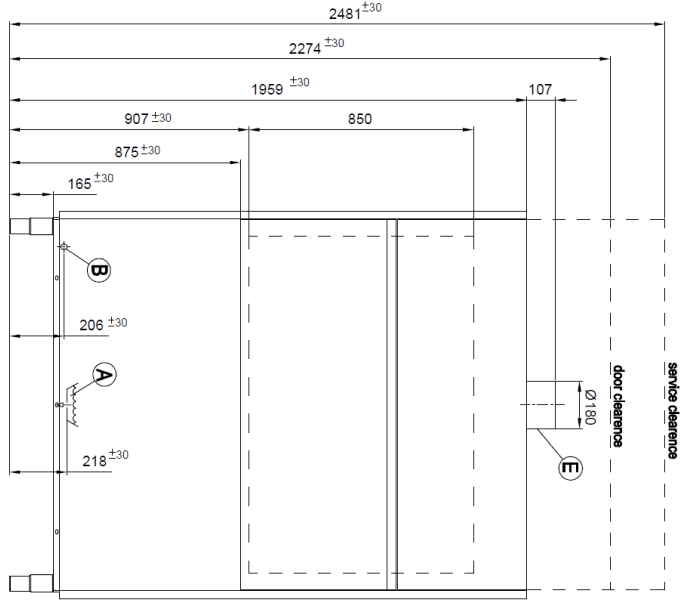
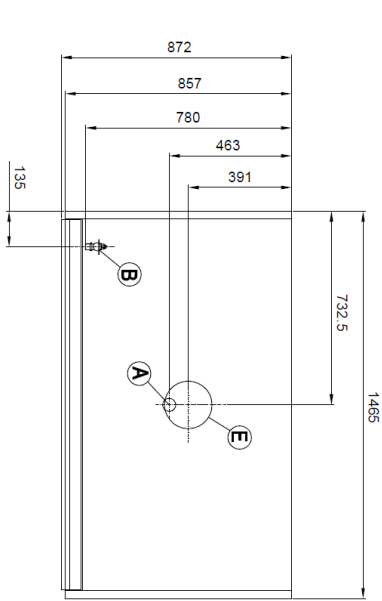

**Installation layout**

Utensil washer , Drain Pump

Code: LP7SP 00

Designed by: MAFERI

Date: 12.10.2018

Determination:

Rev.:

